

Revision			
Rev.	Description	Date	Approved
A-3		2017/6/29	R/D

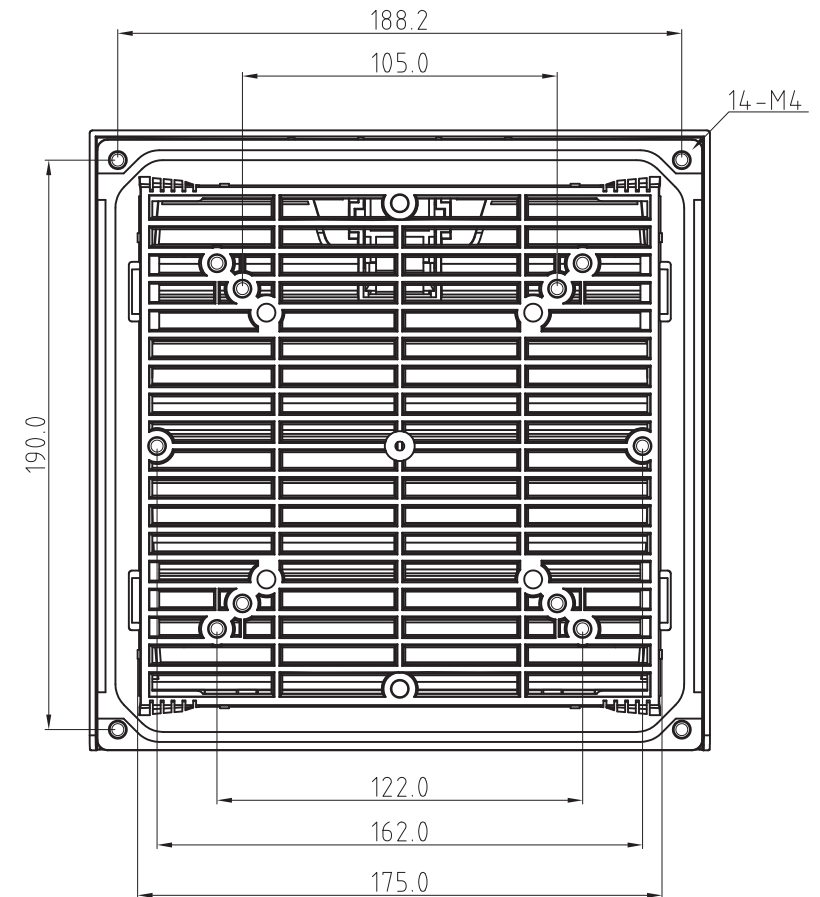
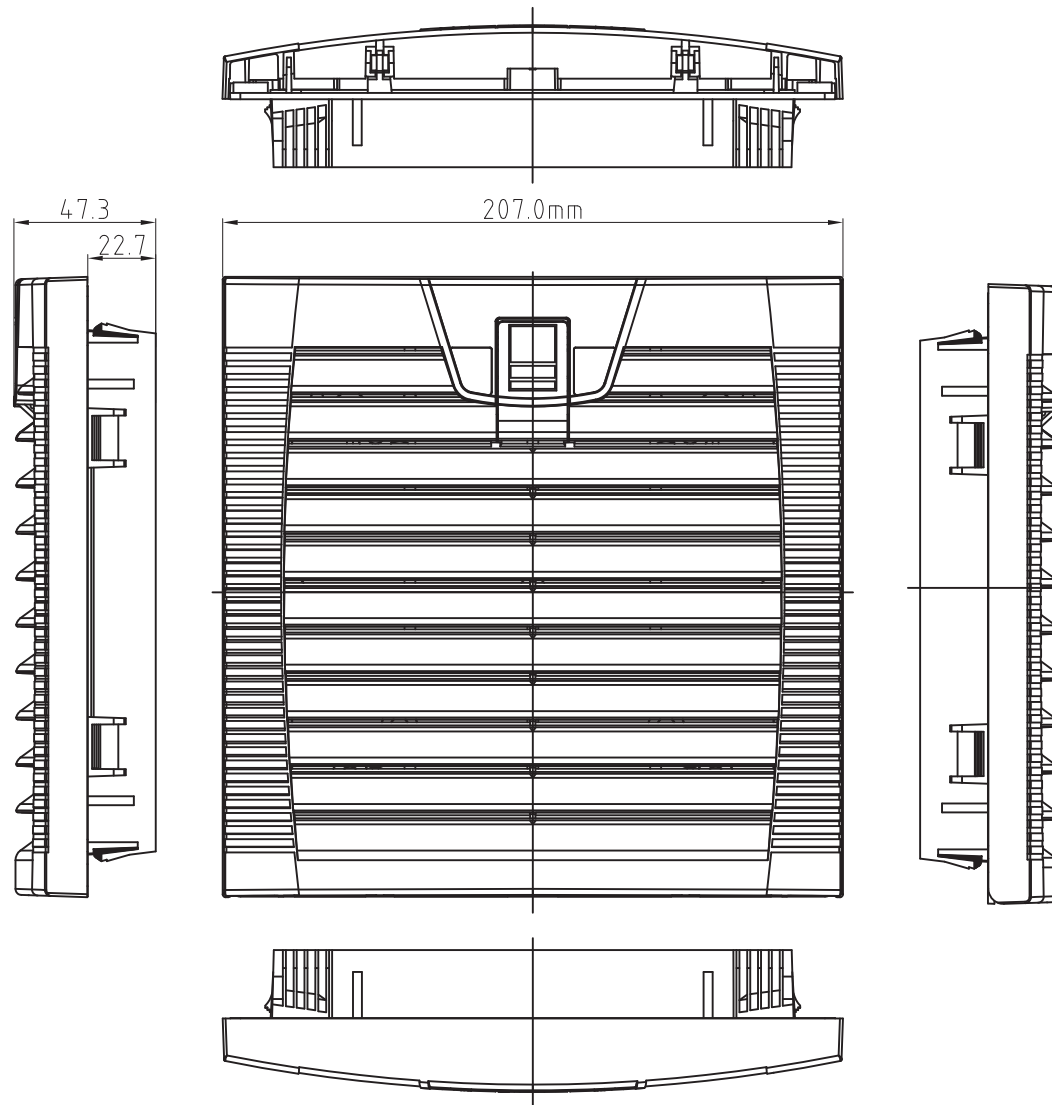

### Specifications:

- Frame: Retainer (R) & Grill (G), Made of thermoplastic ABS resin.  
Filter Media (F): Synthetic Filber.
- General tolerance unless noted is  $\pm 0.5\text{mm}$ . Weight: 308g.

**SINWAN**® Sinwan Electric Industries Co., Ltd.

Part Number:

**RFG172A**

Description:

( Louvered ventilator Filter Kits For 172mm (6.8") Fans )