

Revision			
Rev.	Description	Date	Approved
A-3		2016/6/21	RD

Retainer "R" / R60P

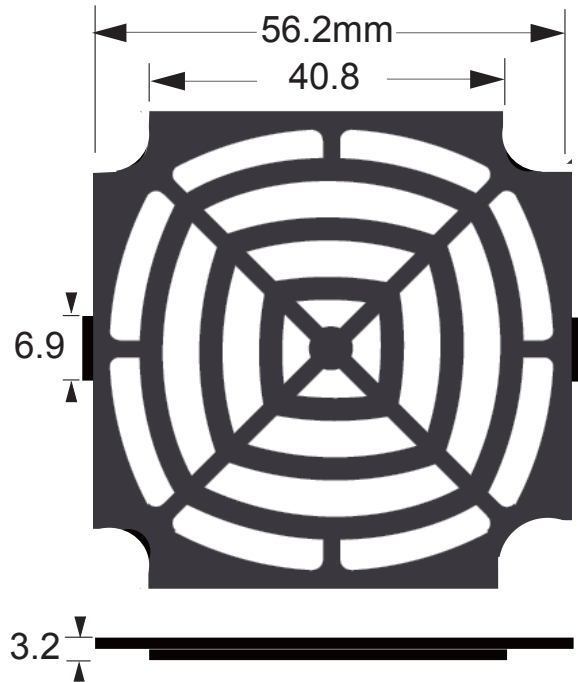

Media "M" / M60-30

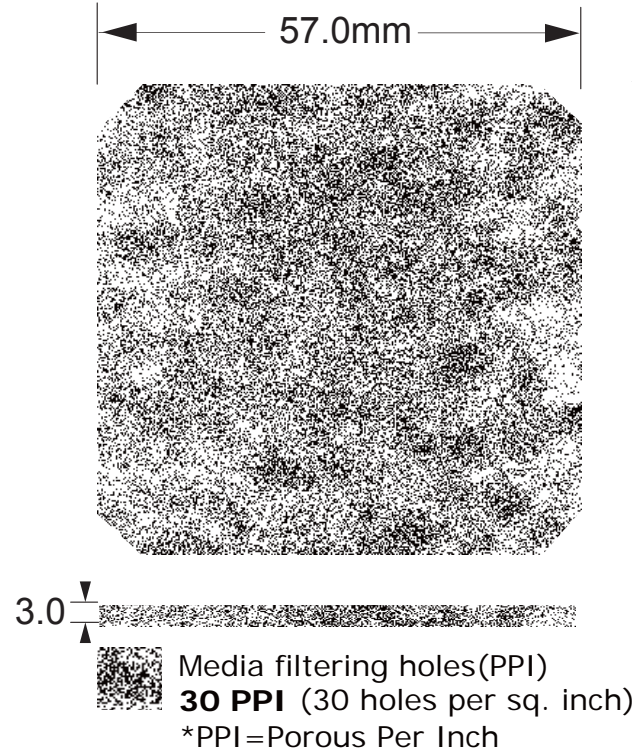

Guard "G" / G60P

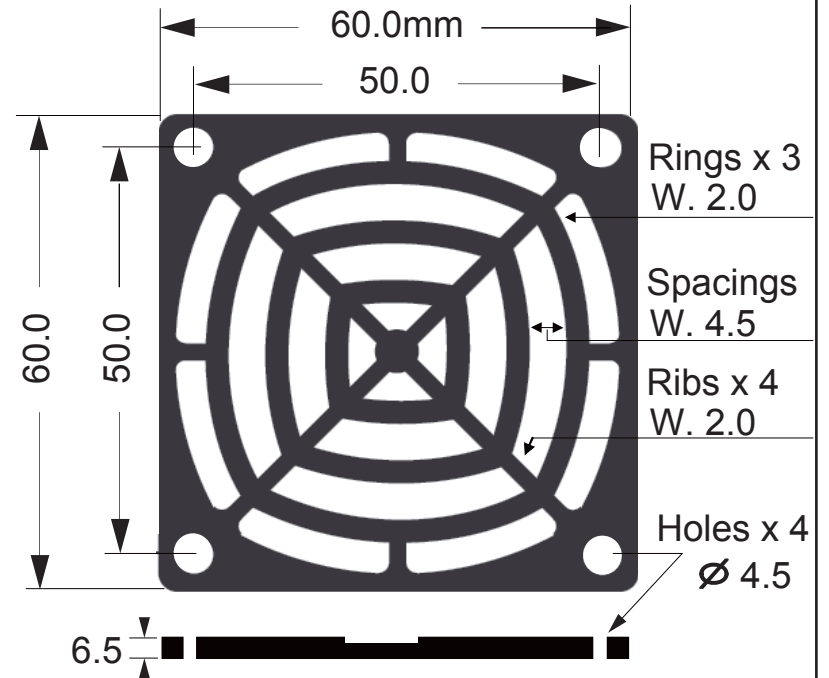

Specification / Material:

- General tolerance unless noted is $\pm 0.3\text{mm}$
- Plastic guard "G" & Retainer "R" made of plastic ABS764 glass reinforced flammability rated UL94V-0
- Media "M" is made of PU form (UL Option)
- Color: black / Filtering holes: 30PPI / Weight: 9.5Gm

 Sinwan Electric Industries Co., Ltd.	
Part Number:	GRM60-30
Description:	(Plastic Fan Filter Kits For 60mm (2.36") Fans)